

DIRECTIONAL VALVE (3-Way, 2-Position, Vent to Shift)

Ordering Code: **DQ-34A-X-Y-Z**

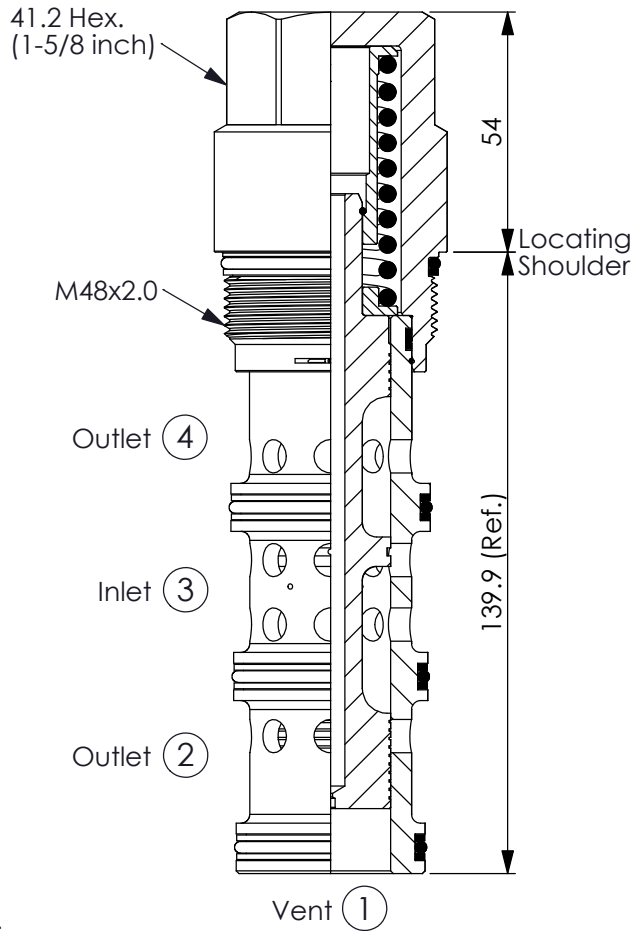

UNIT:mm

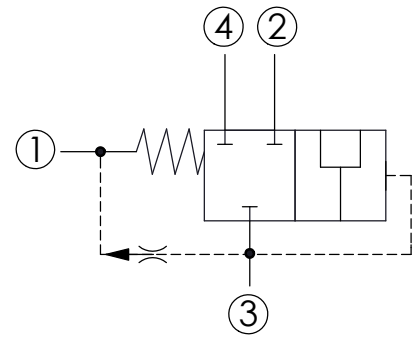

TECHNICAL DATA

Max. pressure:	350	bar
Rated flow:	480	l/min
Cavity-Tooling:	34A-4	
Installation torque:	465 - 500	Nm
Weight:	1.55	kg
Nominal Vent Flow(0.60 l/min.)		

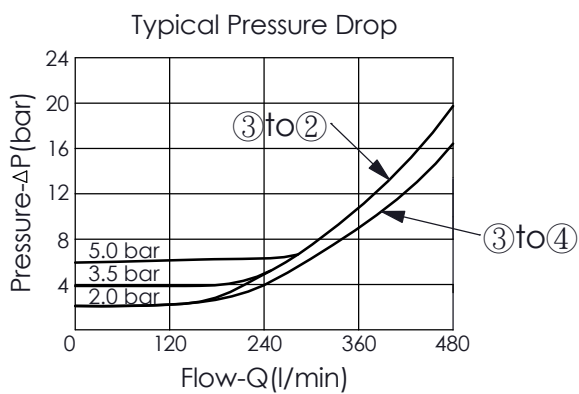

X OPERATION

40 Vent to shift
Normally Closed Diverter

Z OPTIONS

N Non-adjustable

Y SPRINGS

Cracking pressure

20	2.0 bar
35	3.5 bar
50	5.0 bar