

POPPET DIRECTIONAL VALVE (Direct-Acting) (Normally-Closed, Double-Lock, Manually Operated Bi-directional)

Ordering Code: **DT-13A-X-Y-Z-0400**

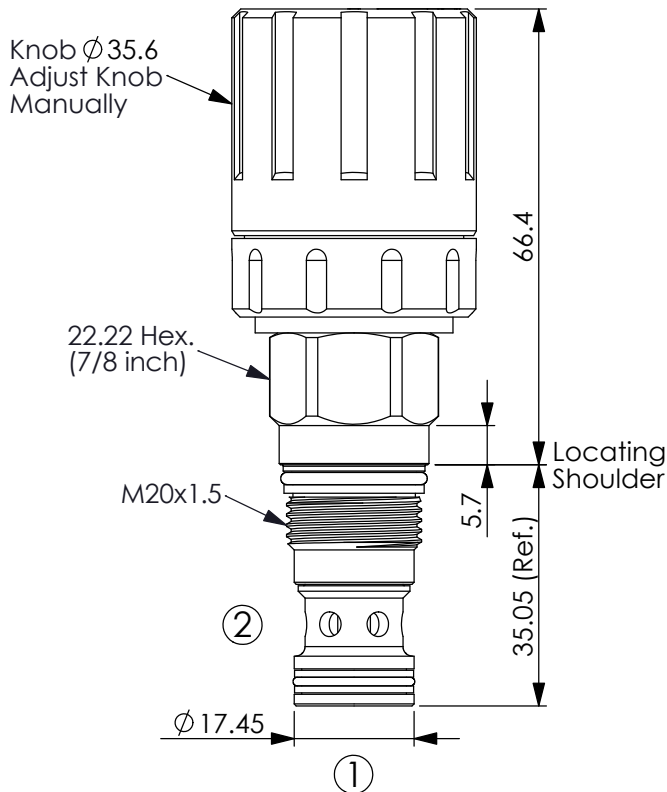

UNIT:mm

Illustrations / detail are for reference only. Data subject to change.

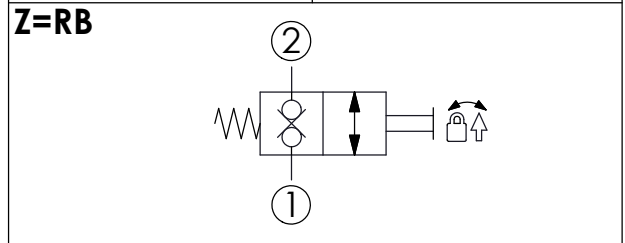
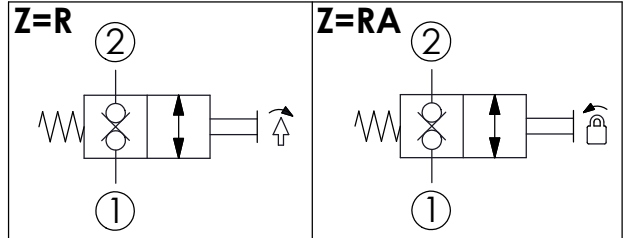

TECHNICAL DATA

Max. Operating pressure: 350 bar
(Refer To Performance Chart)

Rated flow: 40 l/min
(Refer To Performance Chart)

Cavity-Tooling: 13A-2

Installation torque: 40 - 50 Nm

Weight: 0.214 kg

Z=R type:

Turn knob clockwise to achieve override function. Knob will return to starting position automatically when release.

Z=RA type:

Turn knob counterclockwise to locked position (fixed position) to achieve override function. Turn knob clockwise to release, then knob will return starting position.

Z=RB type:

Combining the operation of R type and RA type to achieve override function by turning knob clockwise or counterclockwise. Please refer to R type and RA type instructions.

*Please note that these operations are for emergency use only and are not intended for load holding application.

Performance Chart

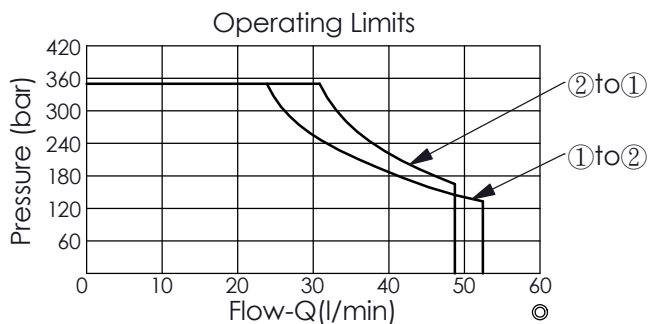
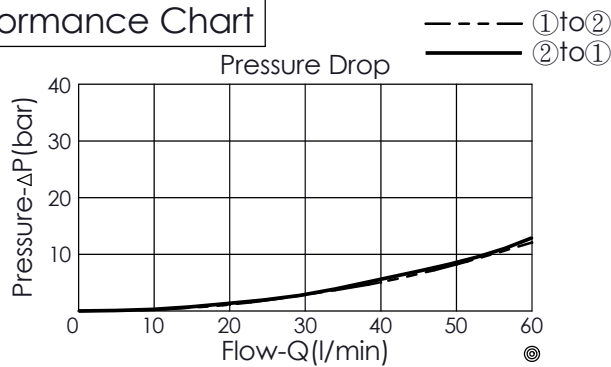

The performance curve or data is only for reference, as customers' using condition, pressure, flow, hydraulic fluid viscosity, cleanliness, temperature and so on are different, the curve or data will be different.

Y OPERATION

51 Direct Acting Normally Closed Type, Double Lock. Manual Operated, Bi-directional.

• The suggested inlet port is port ②.

X STRUCTURE

2A Standard Type

• Maximum Leakage Approximately (10 drops/min./350 bar)

Z OPTIONS

R Manual Override Knob (Clockwise Operation, Return Automatically when Release)

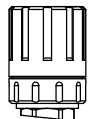

RA Manual Override Knob (Counterclockwise Operation, Return Manually when Release)

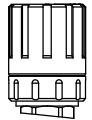

RB Dual Manual Override Knob (Clockwise Operation, Return Automatically when Release) (Counterclockwise Operation, Return Manually when Release)

