

Ordering Code: **EP-13A-X-Y-Z-04**

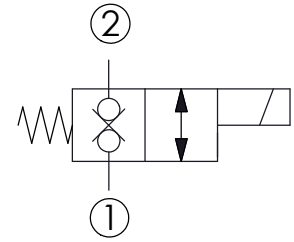
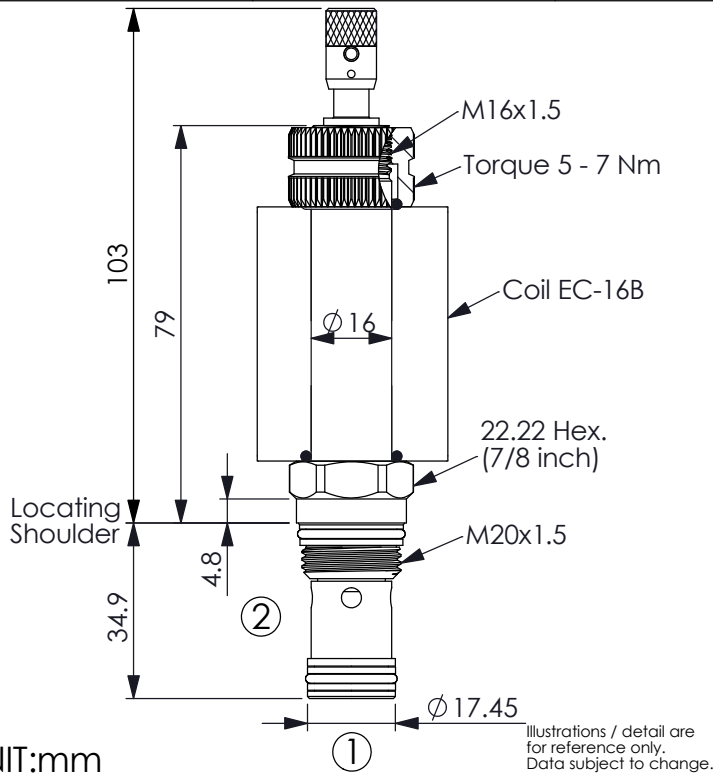

TECHNICAL DATA

Max. Operating pressure: 350 bar
(Refer To Performance Chart)

Rated flow: 25 l/min
(Refer To Performance Chart)

Response Time: Opening 30 - 70 ms
Closing 50 - 70 ms

Cavity-Tooling: 13A-2

Installation torque: 39 - 51 Nm

Weight: 0.174 (Z=N) kg

Internal Leakage Approximately:
0.15 cc/minute
(3 drops/minute) max. at 350 bar

Hydraulic Fluid Viscosity · Cleanliness · Temperature Level:
Please refer WINNER technical information.
(T.101.101.E HYDRAULIC FLUID (A) VISCOSITY)
(T.101.102.E HYDRAULIC FLUID (B) CLEANLINESS)
(T.101.103.E HYDRAULIC FLUID (C) TEMPERATURE)

Minimum Voltage Required:
90 % of nominal

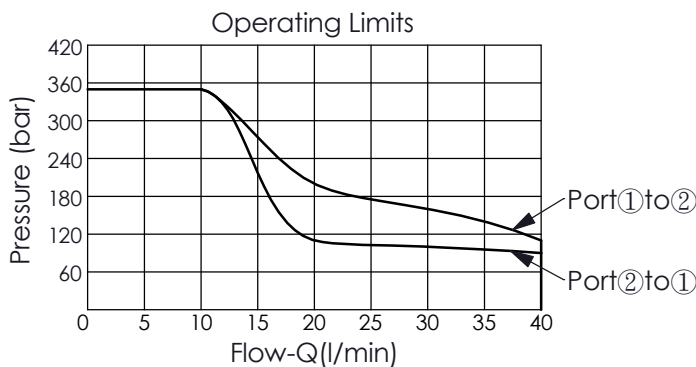
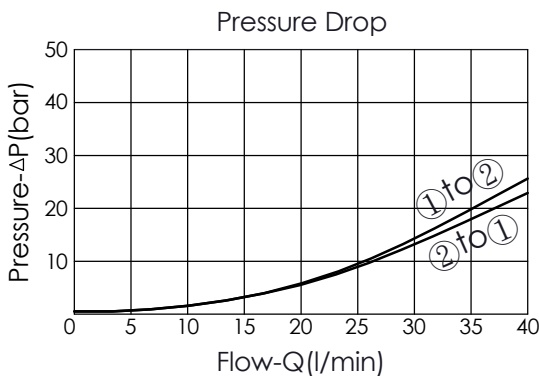

Coils must be ordered separately

Mounting Position: unrestricted



The performance curve or data is only for reference, as customers' using condition, pressure, flow, hydraulic fluid viscosity, cleanliness, temperature and so on are different, the curve or data will be different.

X	STRUCTURE
2C	2 Ports · 26 Watt. Coil Ø 16 mm tube

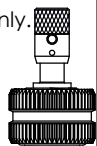
Z	OPTIONS
N	Non-adjustable 
P	Push Style Manual Override 
T	Push and Twist Style Manual Override (For emergency or test use only. Please keep at the normal operational position after turning counterclockwise.) (A larger force is required for downward push during high-pressure operations, please contact Winner's sales department.) 

Y	OPERATION
51	Direct-Acting Normally -Closed Double-Lock, Fast-acting